

# Seam Trim



TERRE HAUTE, IN 47802

**855-23METAL**

WWW.METALSUPPLYDEPOT.COM

## DRIP EDGE

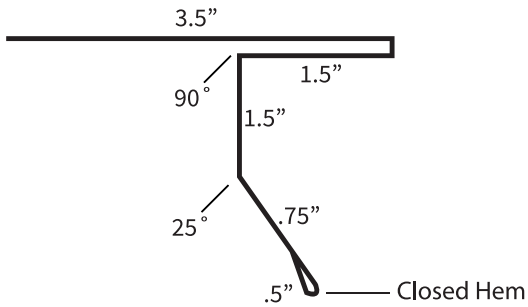

## OFFSET CLEAT

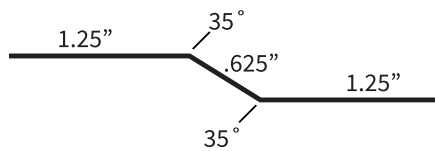

## ENDWALL

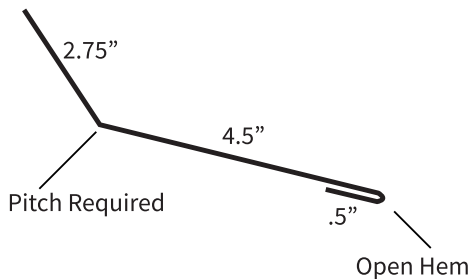

## SIDEWALL

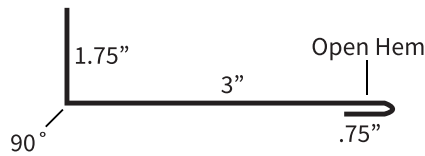

## 1" Z-BAR

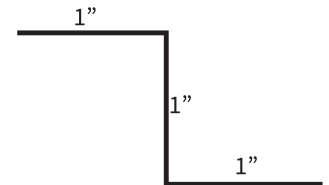

## LOWER TRANSITION

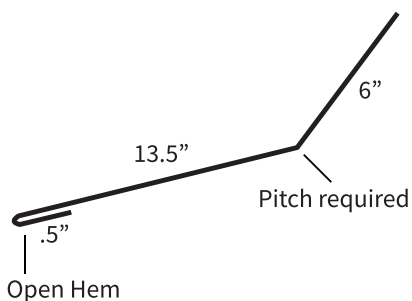

## RECEIVER J-CHANNEL (VENTED OR NON-VENTED)

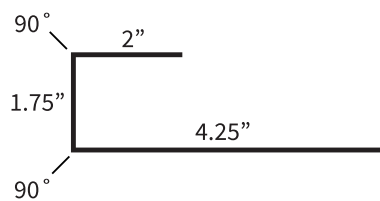

## 1.5" Z-BAR

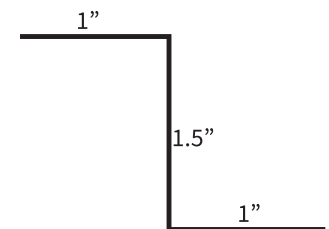

**\*SPECIAL TRIMS AVAILABLE UPON REQUEST. CALL FOR DETAILS\***

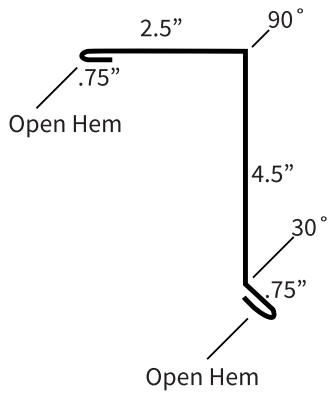
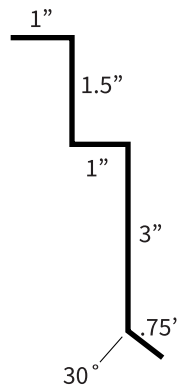
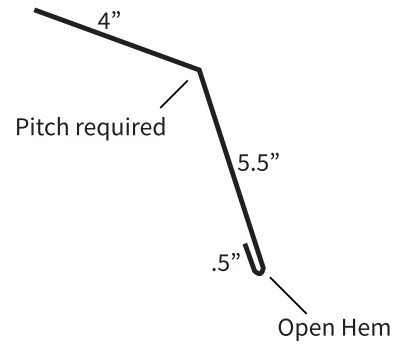
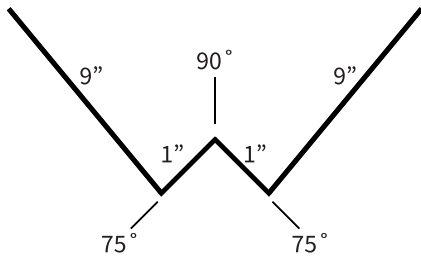
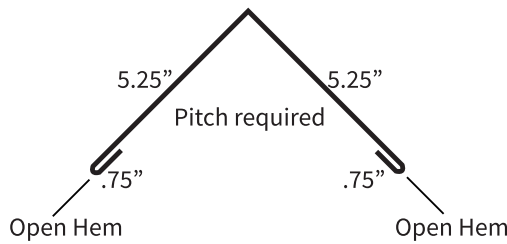
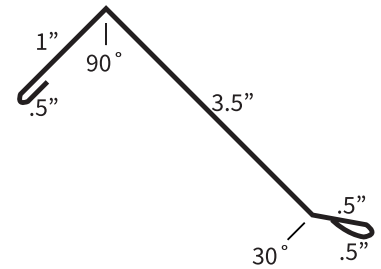
**RAKE**

**RAKE CLEAT**

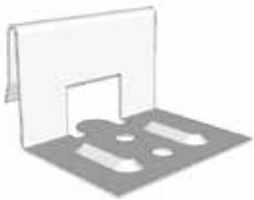
**GAMBREL RIDGE**

**VALLEY**

**RIDGE CAP**

**COUNTER FLASHING**

# Accessories

**Panel Clip**

**Pancake Screws (1" - 2")**

**Color Rivets (50 pc)**

**Boots**

- #1 Split/Zipper Boot Small - 1/4" to 2 1/2"
- #2 Split/Zipper Roof Boot Large - 2" to 7 1/4"
- #3 Hi-Temp Pipe Boot - 1/4" to 5"
- #3 Pipe Boot - 1/4" to 5"
- #5 Hi-Temp Pipe Boot - 4 1/4" to 7 1/2"
- #5 Pipe Boot - 4 1/4" to 7 1/2"
- #6 Pipe Boot - 5" to 9"
- #8 Hi-Temp Pipe Boot - 7" to 13"
- #8 Pipe Boot - 7" to 13"
- #9 Hi-Temp Pipe Boot - 10" to 19"
- #9 Pine Boot - 10" to 19"

**Snow Retention**
