



**METAL
SUPPLY
DEPOT**



ForeverSeam Installation Guide

Important Information

This manual contains suggestions and guidelines on how to install ForeverSeam panels. The drawings in this guide are for illustration purposes only and may not apply to all building designs or product applications. The installation details shown are proven methods of construction, but are not intended to cover all instances, building requirements, designs, or codes. It is the responsibility of the designer/ installer to ensure that the details meet particular building requirements. Consult local building officials to determine the appropriate building design load requirements. It is the buyer's responsibility to verify all applicable code requirements, check all measurements, and determine suitability of product for the job. The buyer is also responsible for determining lengths and quantities needed.

Prior to ordering and installing materials, all dimensions should be verified with field measurements. Implied warranties of merchantability and fitness for a particular purpose are disclaimed.

Metal Supply Depot reserves the right to modify, without notice, information in this guide. If you have questions regarding proper installation of ForeverSeam or information not included in this guide, contact your salesperson.

Safety

Each job site presents different hazards; therefore it is the responsibility of the buyer/installer to determine the safest way to install the ForeverSeam roof panel system based on the recommended instructions contained in this guide. Provide crew members working on the roof with

required safety equipment. If you walk on a metal roof, take great care. Metal panels can become slippery, so always wear shoes with non-slip soles. Avoid working on metal roofs during wet conditions when the panels can become extremely slippery.



OSHA safety regulations should be complied with at all times.

Always wear protective gloves when working with steel panels to avoid cuts from sharp edges.

When cutting or drilling steel panels, always wear safety glasses to prevent eye injury from flying metal fragments.

INDEX

Information in the catalog may vary by plant location.
Please call your salesperson to verify product availability.

Instruction.....	4
Design.....	5
Panel Installation.....	6
Roof Preparation.....	6
Field Cutting.....	6
Conditions of Substructure.....	7
General Installation.....	7 - 9
Fastener Spacing.....	10
Trims.....	10 - 15
Concealed Fastener Trims.....	16
Concealed Fastener Trim Installation.....	17 - 19
Accessories.....	20
Benefits of a Metal Roof.....	21
Advantages.....	21
Warrant.....	21
Ecological Benefits.....	21 - 22
Practical Benefits.....	23
Maintenance.....	23

Introduction

The ForeverSeam concealed fastener panel gives you the leak resistance and beauty of a traditional ForeverSeam roof without the expense and installation difficulty of clips. The fastening slots allow the panel to easily expand and contract with temperature changes. The 1" high rib provides a sharp, well-defined look for residential and light commercial applications.

It can be used for roofing, mansard or fascias. The panels must be applied over a solid substrate on roof pitches of 3:12 or greater. With proper handling and installation, ForeverSeam will provide years of outstanding performance and beauty.

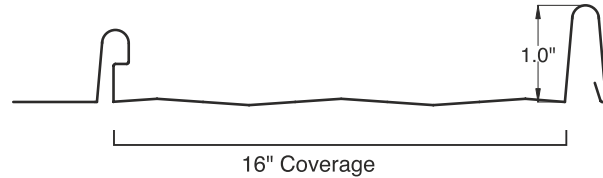

SPECIFICATIONS

Colors and Finishes:

ForeverSeam is available in 26 gauge repainted or bare Galvalume steel. See your representative for a color chart.

Widths:

The ForeverSeam panel provides 16" coverage. The minor striations provide strength and reduce the incidence of oil canning in the panel.

Lengths:

The ForeverSeam panel is custom cut to the half-inch, in lengths from 3' to 40'. Longer lengths require additional handling, packaging, and shipping considerations. An extra handling charge may apply to panels over 40'. ForeverSeam panels cannot be end-lapped. You must order full length panels to avoid end laps.

Rib Height:

ForeverSeam has a 1" high rib, making it an excellent choice for residential and light commercial applications.

CALCULATIONS FOR DETERMINING PANEL LENGTH

One of the trickiest parts of installing a steel roof is ordering the materials correctly. We precut each piece according to your order, to the nearest ½” (from 3’ to 40’), so you must first figure out exactly how many pieces you will need and how long each piece must be.

To figure the length of each section, measure from the top edge of the sheathing (where the roofing will end) to the bottom edge. If the roof will include a ridge vent, the plywood decking and panels should be held 2” back from the ridge. If you are doing an exposed screw at the eave, add about one inch. If you are hemming the panels around the extended eave, add 2.5”. If you are not sure how much to add, call and discuss your project with a representative.

Trim and flashing are available to match the color of the roofing. Each type of trim and flashing must be anticipated and included in the order. Trim pieces come in 10’ or 10’2” might force you to use short pieces to finish a run, so it is better to order the number of pieces needed to complete each separate run.

You may need painted self-tapping screws with gaskets. Painted screws are used for some trims and wherever a screw has to be left exposed to the weather. The screws that secure the roofing panels are hidden, so 1” low profile pancake head screws are used.

Peak, Ridge, Endwall, Hip:

Panels should be started 1” down from the edge or peak (length of run minus 1”). If ridge or peak is ventilated, start sheet down 2” from the edge or peak. This could vary depending on the type of ventilation being used.

INSULATION AND VENTILATION

Proper design and installation of ventilation systems are important to prevent condensation and the resulting problems of moisture damage and the loss of insulation efficiency.

Condensation occurs when moisture-laden air comes in contact with a surface temperature equal to or below the dew point of the air. This phenomenon creates problems that are not unique with metal buildings; they are common to all types of construction.

In addition to providing resistance to heat transfer, insulation can also protect against condensation forming on cold surfaces, either inside the building or within the wall/roof system cavity. The arrangement of the building’s insulation system and vapor retarder is the responsibility of the building designer. There are some basic guidelines to help control condensation in a metal building:

- The insulation should have a vapor retarder face on the “warm” side of the insulation. For most buildings, this means that the vapor retarder is on the inside surface (toward the building’s interior).

- The thickness of the insulation must be designed to maintain the temperature of the vapor retarder above the interior dew point, using the worst-case expected outside temperature.
- All perimeter conditions, seams, and penetrations of the vapor retarder must be adequately sealed in order to provide a continuous membrane to resist the passage of water vapor.
- Building ventilation, whether by gravity ridge vent, power-operated fans, or other means contributes significantly to reduce condensation. The movement of air to the outside of the building reduces the interior level of vapor pressure.
- On buildings that have an attic space or are being retrofitted with a metal roofing system, proper ventilation needs to be used in order to prevent a buildup of moisture (humidity) in the attic space.

TIP

Contact your local building code officials or an engineer on proper ventilation practices for your area.

ROOF PREPARATION

Reminders:

- ForeverSeam is designed to be installed over solid decking.
- Make sure any existing decking is smooth, level and in good condition. Replace any decking not meeting those requirements.
- In most cases ForeverSeam can be installed over existing shingles. Check local building codes to confirm this is possible in your area.
- If installing over existing shingles, we recommend the use of 30 lb felt or synthetic underpayment over the shingles first to keep the rough side of the shingles off the backside of the panels.
- Make sure the roof is clear of any debris that might interfere with installation.
- Use an alignment or “chalk” line where the first panel is installed. We recommend that this line be vertical and ¼” from the rake edge of the roof deck and square with the eave. Other methods of confirming squareness can also be used.

FIELD CUTTING

There are a number of ways to cut sheet metal quickly and accurately. Tin snips or a “nibbler” type electric tool are recommended for the field cutting ForeverSeam panels. A TurboShear drill attachment works well for long cuts. Cutting over a trash barrel will help catch the tiny metal shavings that the machine produces.

Metal Supply Depot does not recommend cutting panels with a circular or abrasive saw.

The main problem is that the heat produced had a negative effect on the paint and substrate adhesion, causing it to prematurely corrode. The other problem is that the metal slivers produced can become embedded into the panel surface.

You can use a special non-heating metal blade designed for metal roofing to prevent heat. To prevent the metal chips from becoming embedded into the surface, panels can be flipped over when cutting. This allows the slivers and metal chips to be brushed from the backside and avoid damaging the paint on the top side of the panels.

All product surfaces should be free of debris at all times. Installed surfaces should be wiped clean at the end of each work period. Never cut panels over metal surfaces. Metal shavings will rust on the surface. When cutting metal panels, goggles must be worn for eye protection.

CONDITION OF SUBSTRUCTURE

Panel distortion may occur if not applied over properly aligned and uniform substructure.

The installer should check the roof deck for squareness before installing ForeverSeam panels. Several methods can be used to verify squareness of the structure for proper installation of the panels.

Method A - One method for checking the roof for squareness is to measure diagonally across one slope of the roof from similar points at the ridge and eave and obtain the same dimension.

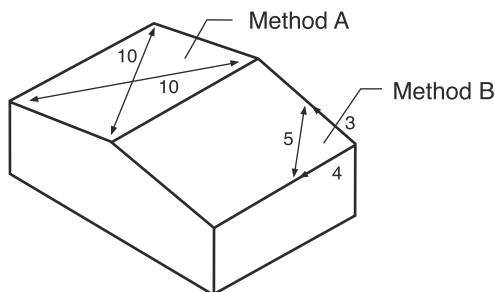

Method B - The 3-4-5 triangle system may also be used. To use this system, measure a point from the corner along the edge of the roof at a module of three (3). Measure a point from the same corner along another edge at a module of four (4). Then, by measuring diagonally between the two points established, the dimension should be exactly a module of five (5) to have a square corner. Multiple uses of this system may be required to determine building squareness. If the end wall cannot be made square additional adjustments will have to be made.

GENERAL INSTALLATION

Familiarize yourself with all installation instructions before starting work. Before beginning installation, you should examine the substrate or framing to ensure that all supporting members are straight, level, and plumb to avoid any panel distortion. Substructures should be designed to meet all necessary code requirements.

Some field cutting and fitting of panels and trims is to be expected by the installer and minor field corrections are a part of normal installation work.

It is the responsibility of the installer to ensure a suitable substrate prior to the application of ForeverSeam. Distortion in the panel caused by an uneven substrate, ripples, or laps in the vapor barrier, debris, protruding nails and staples, etc., are not defects in the materials and are not the responsibility of the Metal Supply Depot.

All trims, tools, and accessories shown on the installation drawings are available from Metal Supply Depot unless noted otherwise.

Oil canning in the flat area of the panels is common to the industry and does not affect the integrity of the panel. Therefore, oil canning is not a reason for rejection. Striations greatly reduce the chance of this happening.

The panels should be installed plumb, straight, and square to the eave. To keep the bottom edge of the roof perfectly straight and even, the panels must be installed square to the bottom edge. Begin by checking the roof for square; if it is square, you may pull the layout marks directly from the edge of the rake.

If the roof isn't perfectly square, install the first panel parallel to your square line, making sure that the first rib does not hang over the gable edge of the roof sheathing. (Any overhang can prevent the gable trim from fitting tight against the rake.)

GENERAL INSTALLATION (cont.)

1. Align the female edge of the first panel with the chalk line that was snapped at the rake edge. This line can be 0" - 1 3/4" from the rake. Panel should overhang eave 1". See Figure 1.

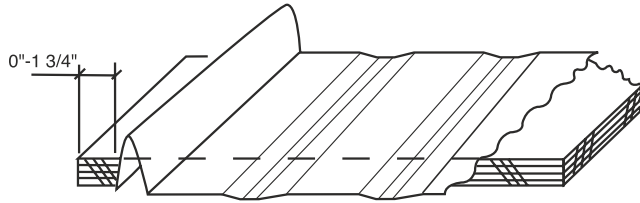

Figure 1

2. Panels should be installed perpendicular to ridge for ridge trim attachment.
3. Check panel alignment. If panel is properly aligned, attach rake edge to roof with a 1" painted neoprene wood grip spaced at 48" on center. See Figure 2. Then fasten the panel along the male edge fastening flange with 1" low profile pancake head. Special care has to be taken not to overdrive the screws in the male edge fastening flange. The screw flange is slotted to allow for slight panel movement during normal expansion and contraction. To avoid panel distortion and to allow for maximum expansion and contraction of the panel, the screws should be snug that the flange deflects under the screw head. To allow for movement of the panel towards the eave or ridge, place the fastener in the middle of the 5/8" slot. See fastener spacing section on page 12.1.

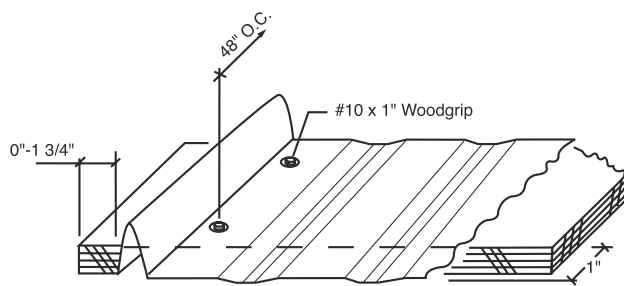

Figure 2

4. Align the second panel female edge with the starter panel male edge. See Figure 3. Panels must be flush to one another. Remember, panels should extend over eave trim by 1".

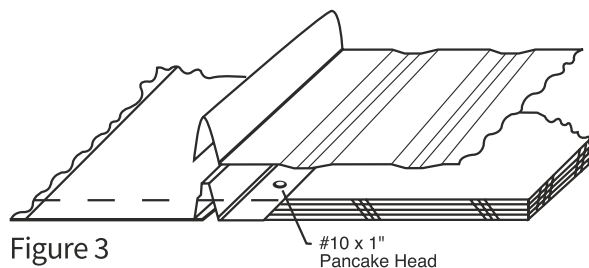

Figure 3

5. Lightly compress and snap panels together at seam. Snap panels from eave to ridge. Screw the second panel in place using 1" pancake head screw in the male edge fastening flange.
6. Continue to apply panels as in steps 4 and 5.
7. Panels at the eave can be terminated in two ways. Each will depend on aesthetic consideration determined by the installer or building owner.

A. Panels can be fastened along the eave with a #10 x 1" painted neoprene wood grip fastener. Fasten along a line parallel to the eave edge and 3" up from the eave edge. The fasteners can be spaced 4" apart in the minor rib striations as shown in Figure 4.

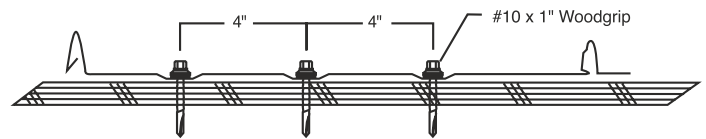

Figure 4

TIP When using the extended eave condition to terminate the eave, panels must be ordered 2 1/2" longer than your eave length to account for the drip edge lip and the panel's hem.

B. Panels can also be terminated with a hemming tool to provide a smoother appearance. Cut through male and female legs/ribs 1" up from panel end as shown in Figure 5.

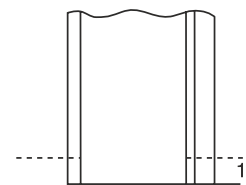

Figure 5

Then cut on the inside of the major ribs with metal shears as shown in Figure 6.

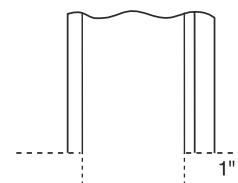
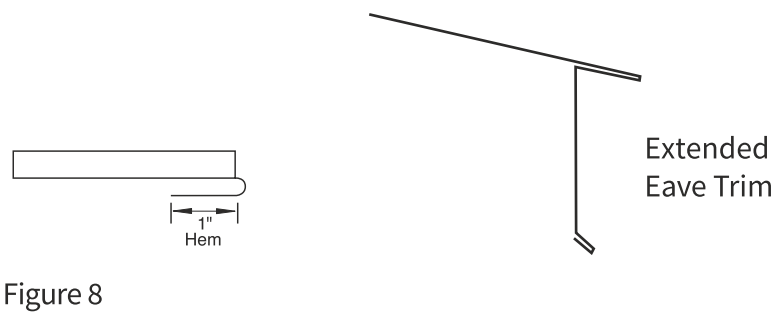
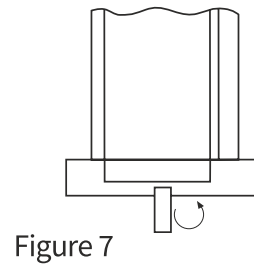

Figure 6

GENERAL INSTALLATION (cont.)

Place hemming tool over panel tab. Bend down and under to 180° as shown in Figures 7 and 8.



The panel is then ready to be installed over the Extended Eave trim, using the lip on the trim to secure the panel in place at the eave.

NOTE: When using the extended eave condition, the panel length must be ordered 2 1/2" longer than your eave to account for the extended eave lip and the panel hem.

FASTENER SPACING

Maximum fastener spacing for 16" wide 26 gauge panels with wind loads up to 80 mph:

Deck Thickness	Spacing
1/2"	12 - 18" o.c.
5/8"	21" o.c.
3/4"	24" o.c.

At the other end of the roof, again make sure that the last panel does not stick out past the edge of the barge rafter. If you don't end with a rib along the edge, rafter. If you don't end with a rib along the edge, the panel to that width. The extra inch of material is bent up with a hand seamer to form a rib.

Trims

Screwing down the roof panels always goes quickly. Installing the trim is the more time-consuming part. Some trim options use attached with gasketed screws; take care to drive the screws enough to flatten the neoprene washer but not enough to deflect the roofing or the trim.

The tricky part is finishing the ends of each trim run. It may take a bit more time, but cutting and folding the ends of the trim will give the roof a more finished look.

TIP When hooking the hem, measure over on hem 3" from end of trim piece. Cut hem 1/8" up from the bend to 3" mark. Cut off back of hem. On lap piece, open up hem with screwdriver. Insert piece. Slide together.

Exposed Eave Trim (details page 11)

Eave trim must be installed prior to panel installation. Also, panel should overhang the eave 1" minimum. Attach eave trim to roof decking with 1" pancake head fastener. Caulk and lap the trim a minimum of 3", hooking the hem. Install panel and fasten at eave with painted 1" wood grip fastener.

See exposed eave trim Figure 9.

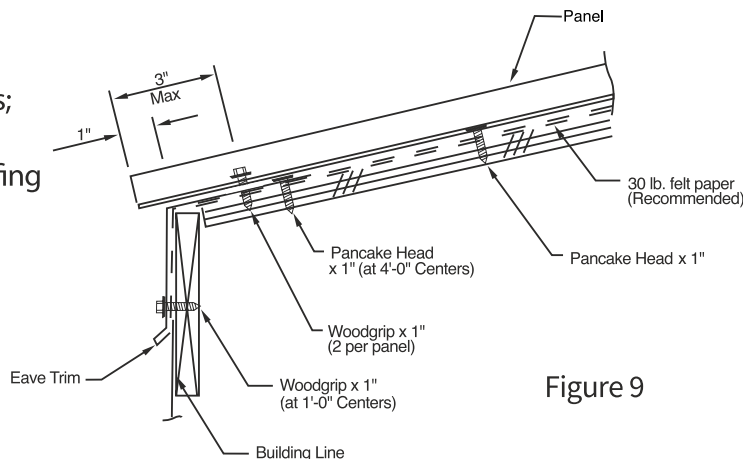
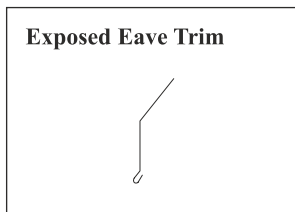
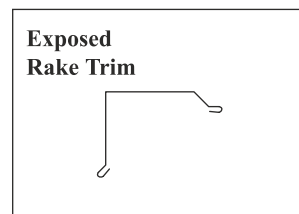

Figure 9

NOTE: We recommend the hidden fastener extended eave option found on page 18, with panel ends cut and hemmed as shown on pages 8 - 9.

Exposed Rake Trim (details page 14.1)

Exposed Rake trim should be installed from the bottom of the roof, working up to the peak with each upper piece overlapping the one below. Place butyl tape along the trim's flange. Install rake trim over rib. Fasten using 1" painted wood grips at 12" o.c. Caulk and lap the rake trim about 2 - 3". Miter cut the rake trim at the peak to join each side at the ridge. Cut and fold the rake at the eave to deal the end. Use painted blind rivets to fasten.



Exposed Fastened Eave - Details

Extended Eave trim must be installed prior to panel installation. Also, panel should overhang the eave 1" minimum.

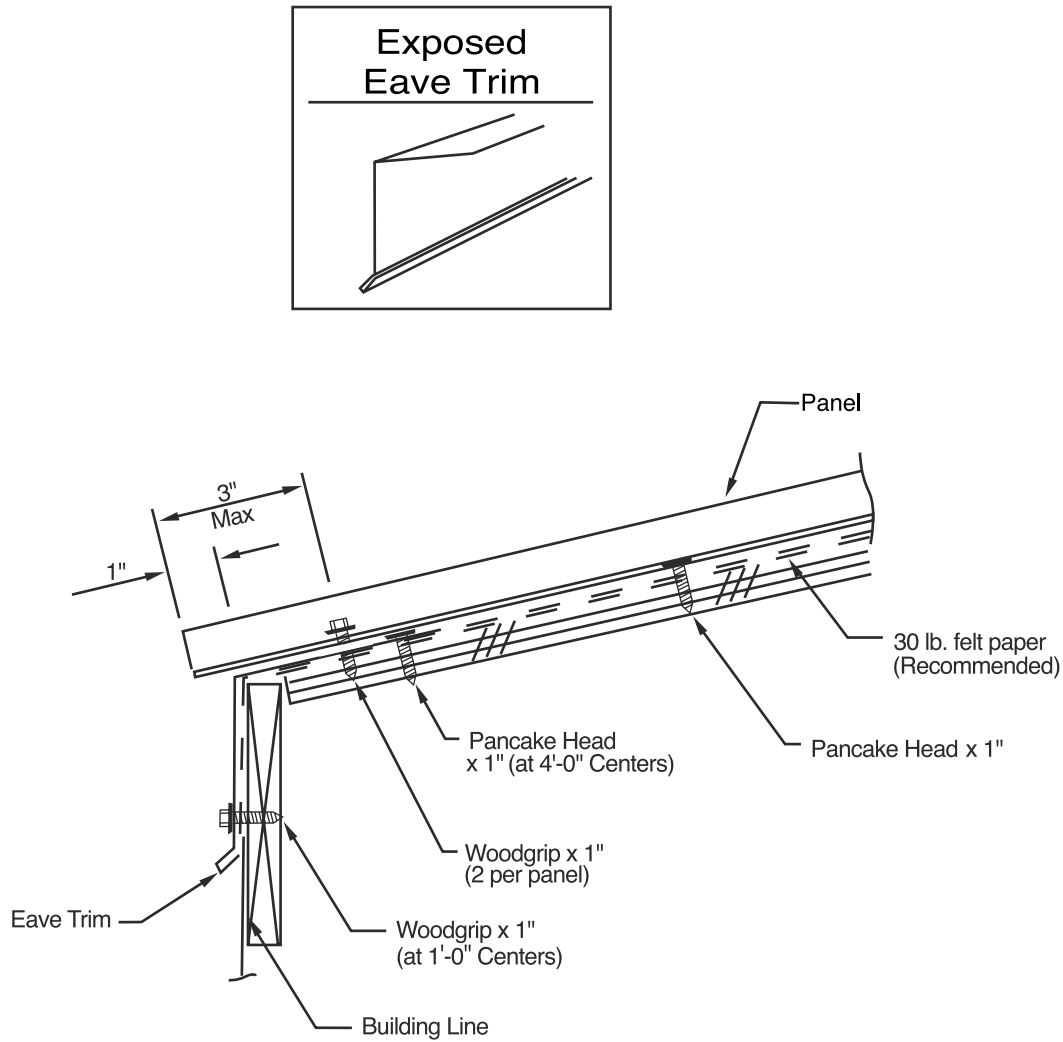

Attach eave trim as shown with #10 x 1" low profile pancake fastener. Open the hem of the next trim for approximately 4". Caulk and lap the trim a minimum of 3" hooking the hem. Install panel and fasten at eave with #10 x 1" Woodgrip screw. Additional ice and water shields may be required if climate is extreme.

Exposed Fastened Rake - Details

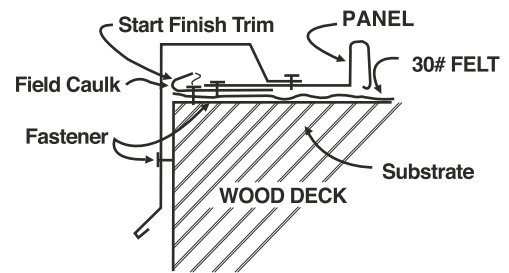
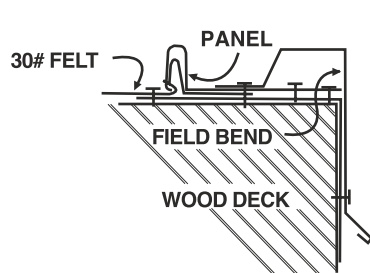
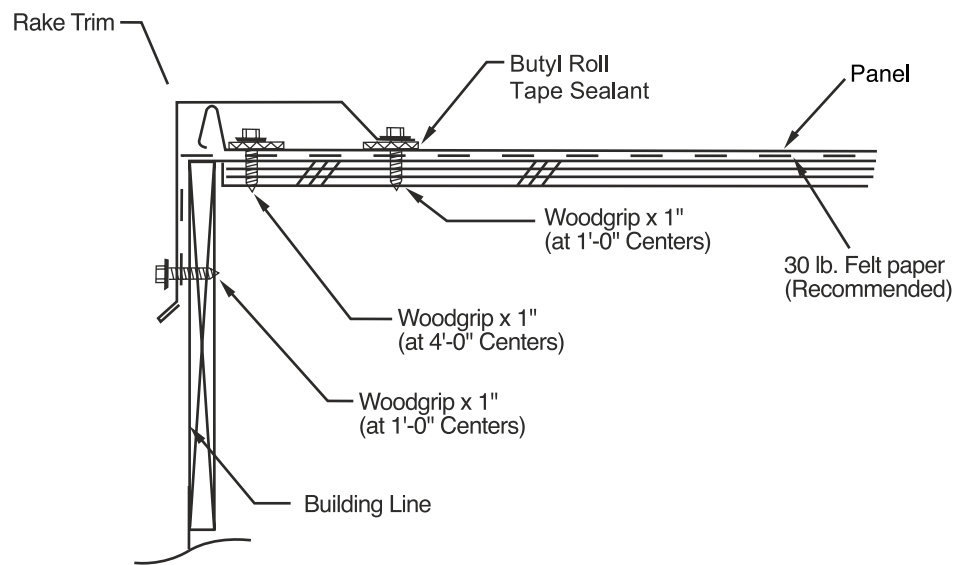
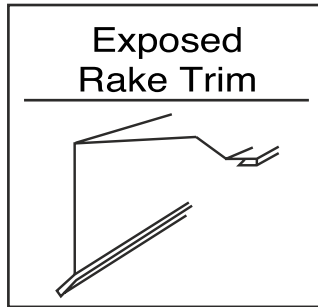

Begin by aligning ForeverSeam panel flush to the gable end of the building and attaching the flange side of the panel with pancake head screws. Assemble the Exposed Rake Trim with #10 x 1" washered screws as shown with screws 18" to 24" apart.

Pancake head screws should be placed 12" to 18" on center along the flange at flush depth.

BE SURE FASTENER HEADS ARE FLUSH WITH THE PANEL FLANGE. DO NOT OVERDRIVE SCREW AS IT WILL INCREASE OIL CANNING IN THE PANEL. DO NOT UNDERDRIVE THE SCREWS OR THEY WILL LEAVE BUMPS ON THE SNAP LOCK EDGE.

Ridge and Hip Caps (details page 15.1)

TIP Rake trim must be installed prior to installing the ridge. Panels must be field cut at hip.

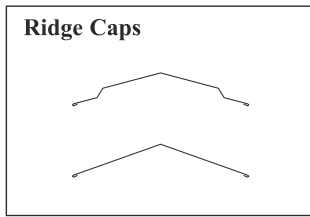

Attach see closure parallel to closure ridge. Fasten hip/ridge trim to the see using lap screws or preferably pop rivets. Caulk, lap and fasten the subsequent trims.

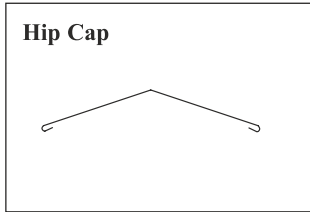

Place a short section of ridge cap on one end of the peak so it lies evenly side to side. Mark the outside edges, then repeat the process at the other end. Snap chalklines between the marks, and set the ridge cap on these lines as it's installed.

Exposed Valley Trim (details page 16.1)

TIP Exposed Valley trim must be installed prior to panel installation. Panels must be field cut at an angle.

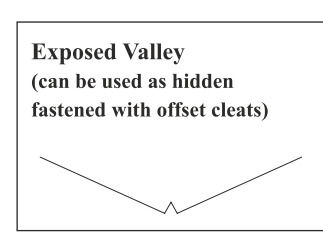

Place another layer of 36" roof felt on valley centerline with 18" of paper on each side of center. Begin placing valley trim at eave with a 1" overhang. Caulk and lap the sequential valley trims a minimum of 6". Parallel to the valley, place butyl tape sealant 6" from valley center. Field cut the panels allowing for overlap with valley trim and hem. Make cuts through male/female rib (depending on side) at the angle required for the specific roof slope. After panels are field cut and attached, fasten along bottom end using four 1" Woodgrips per panel. Make sure fasteners are evenly spaced and penetrate the row of butyl tape. Seal panel end with tube caulking.

After the trim has been installed, the final step is to drive two evenly-spaced gasketed screws along the bottom edge of each panel.

Ridge & Hip Trim Details – Exposed Fastened

Rake trim must be installed prior to installing the ridge. Panels must be field cut at hip.

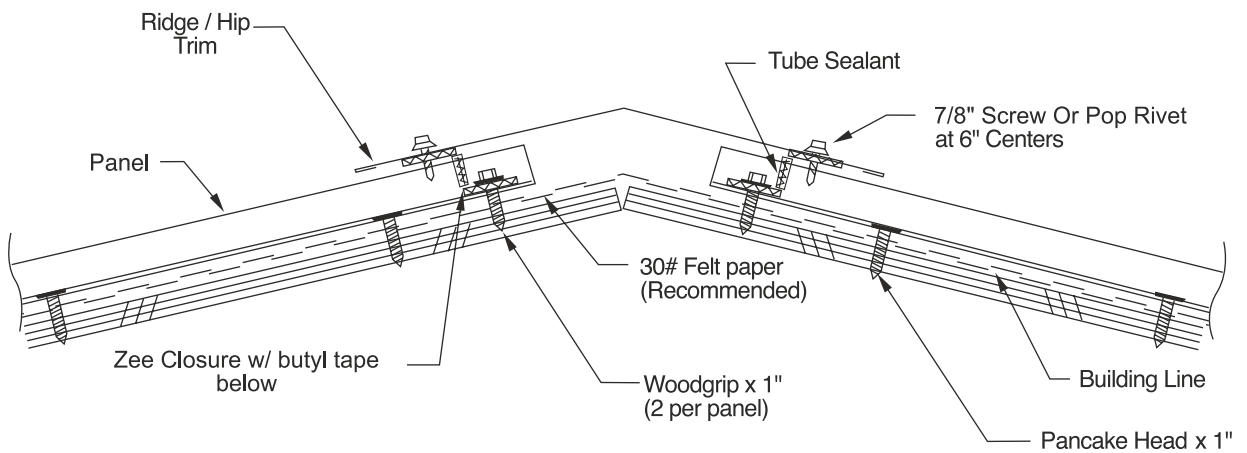
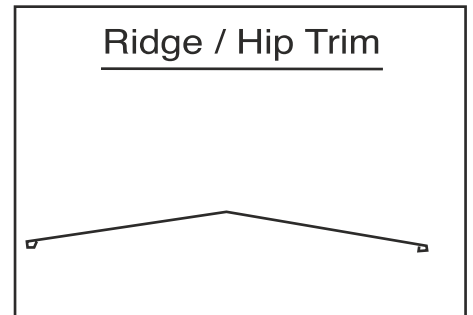
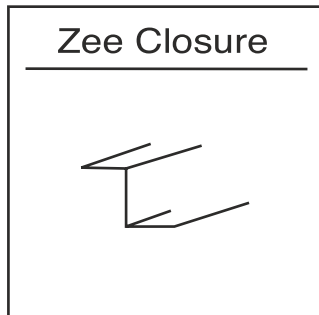

Panels should end parallel to the ridge. Attach zee closure parallel to closure ridge. Fasten hip/ridge trim to the zee using #14 x 7/8" Lap/screw. Caulk, lap (minimum of 6" hooking the hem) and fasten the subsequent trims.

Valley Trim Details – Exposed Fastened

Valley trim must be installed prior to panel installation. Panels must be field cut.

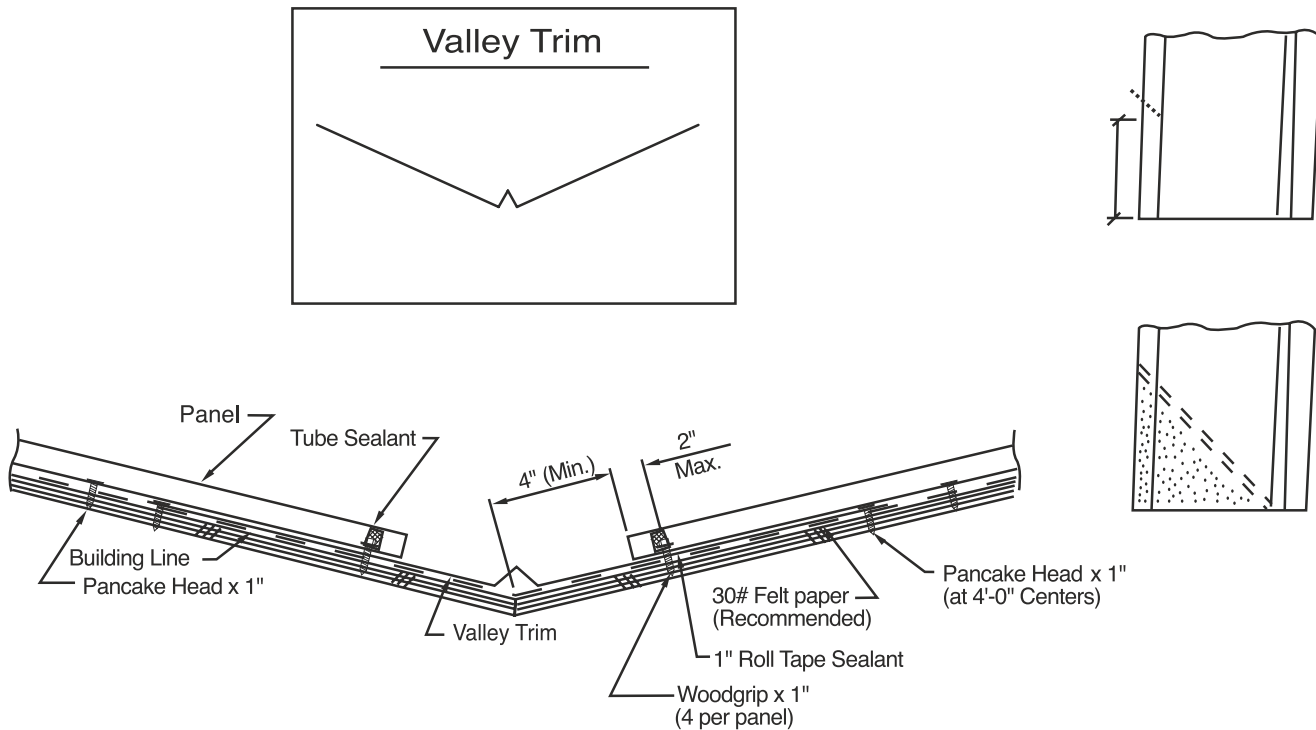

Place another layer of 36" roof felt on valley centerline with 18" of paper on each side of center. Begin placing valley trim at eave with a 1" overhang. Caulk and lap the sequential valley trims a minimum of 6". Parallel to the valley, place tape sealant 6" from valley center as shown. Field cut the panels allowing for overlap with valley trim. Make cuts through male/female rib (depending on side) at the angle required for the specific roof slope. Cut out shaded or marked area with sheet metal shears. After panels are field cut and attached, fasten along bottom end using four (4) #10 x 1" Woodgrips per panel. Make sure fasteners are evenly spaced and penetrate the row of tape sealant. Seal panel end with tube caulking. Additional ice and water shields may be required if climate is extreme.

Concealed Fastener Trims

Extended Eave Trim

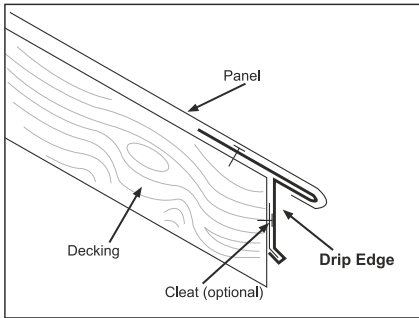

Ridge Cap

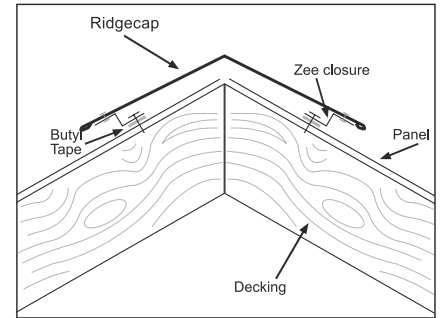

Cleat

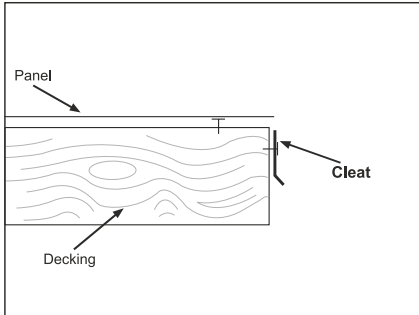

Sidewall

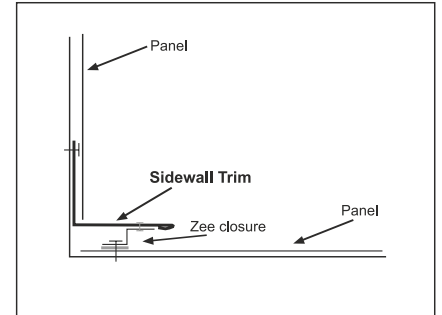

Rake Trim

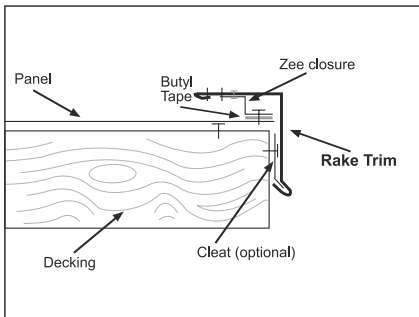

Transition

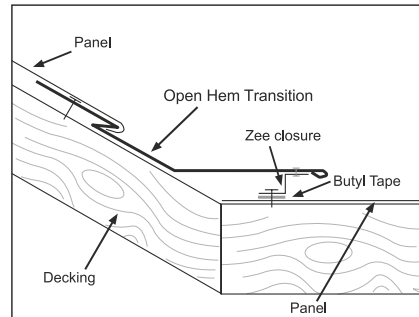

Many plants do not have an Open Hem Transition. At these plants, use a standard transition and an offset cleat to get the same hidden fastener result. See the trim details guide for more information.

Offset Cleat
Standard Transition

Zee Closure

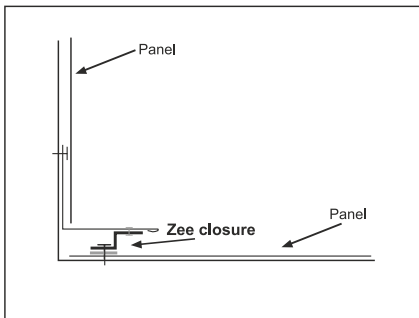

Valley

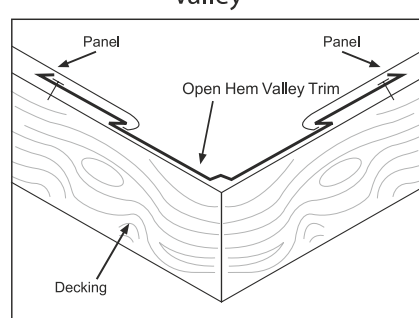

Many plants do not have an Open Hem Valley Flashing. At these plants, use a valley and two offset cleats to get the same hidden fastener result. See the trim details guide for more information.

Offset Cleat
Standard Valley

Tools

Hand Snips

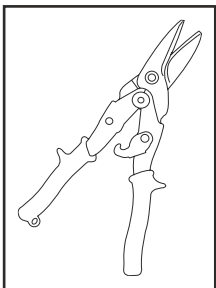

Notchers

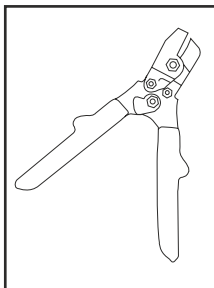

Rivet Hole Punch

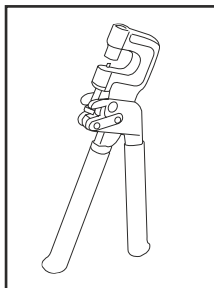

Hand Riveter

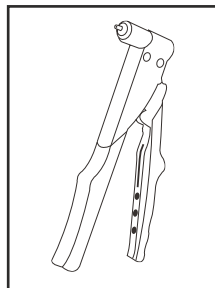

Folding Tools

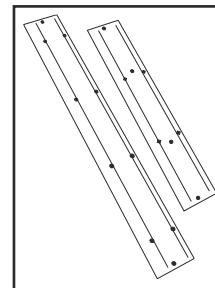

6" Hand Seamer

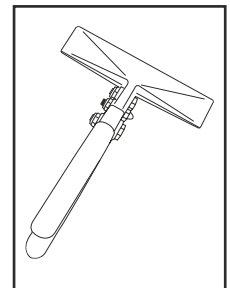

Installation of Trims

DRIP EDGE

When ordering panels, be sure to add an extra 2" to the length for hemming over the drip edge. (One inch covers the drip edge and one inch is hemmed under).

1. Screw the drip edge to the decking.
2. Notch the ForeverSeam panels at the rib (1" from the end of the panel).
3. Using the folding tool, fold the panel at the notching so that the unpainted sides of the panel are facing each other.
4. Slide panel over drip edge and screw into decking.
5. Repeat steps 2 - 4 for each ForeverSeam panel along the drip edge.

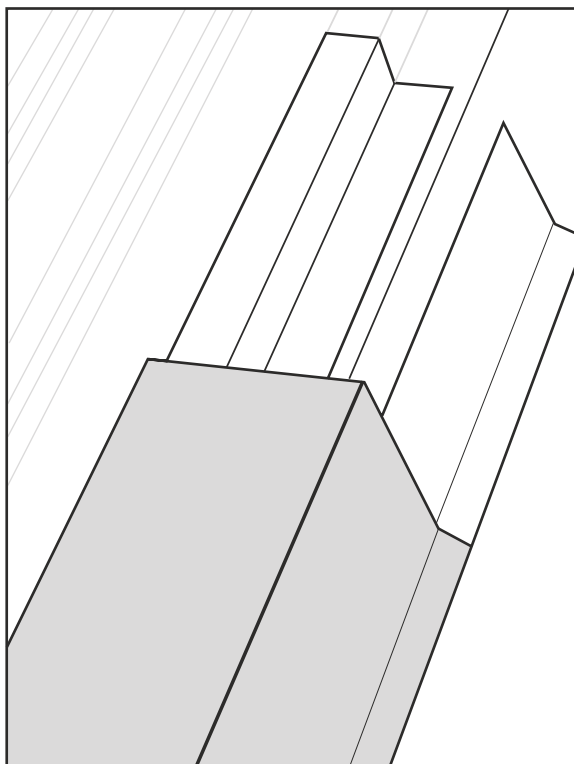
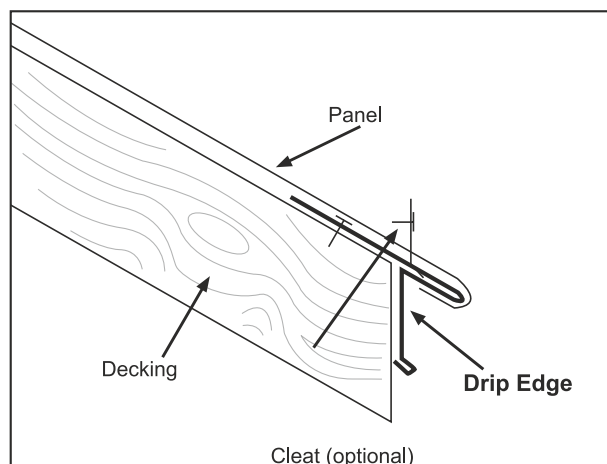
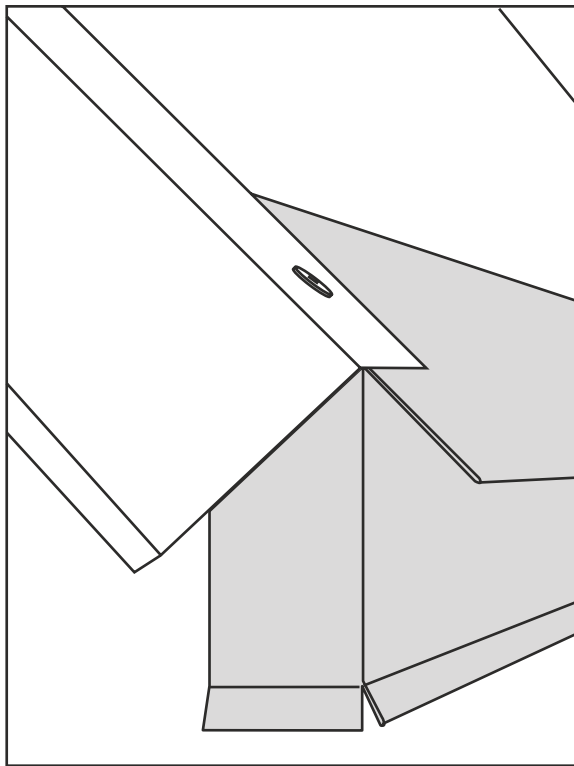

RAKE TRIM

1. Install the cleat along the rake of the roof and install ForeverSeam panel on top of the cleat. The edge of the panel should meet with the edge of the rake.
2. Install zee closure on top of the panel. Use butyl tape beneath to ensure proper sealing. Run the zee along the length of the rake and screw down to the panel.
3. Install the rake trim over the cleat and zee. Pop rivet the rake to the zee along the joints and every 1 - 2 feet along the rake.

Overlap trims a minimum of 3" with butyl tape between laps.

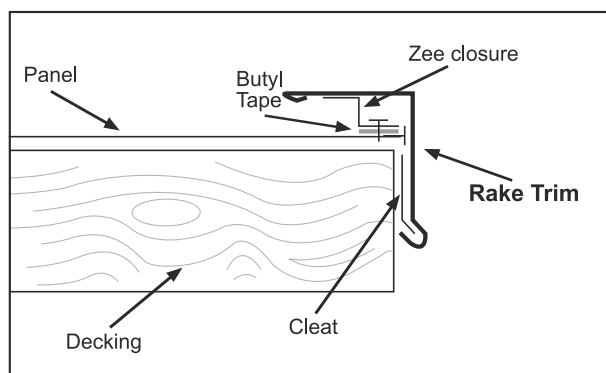

Installation of Trims (cont.)

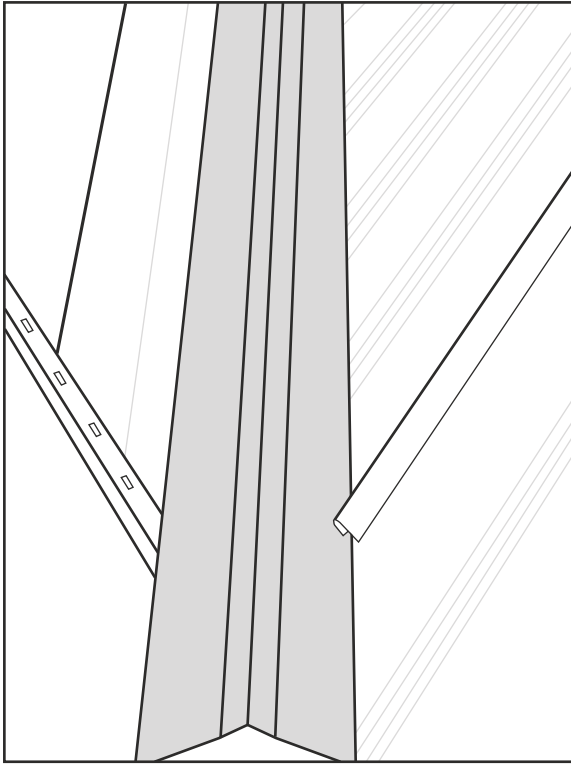

VALLEY TRIM

1. Using the folding tool, hem the end of the valley 1" and slide over drip edge (if drip edge is being used).
2. Install valley to decking, placing screws as far up as possible on the 4 - 7/8" section of the valley.
3. Hem the panel at a 45° angle (or according to the valley pitch) where it meets the valley and slide under the open hem on the valley.
4. Repeat step 3 for each panel as it meets in the valley. Overlap trims a minimum of 6" with butyl tape between laps.

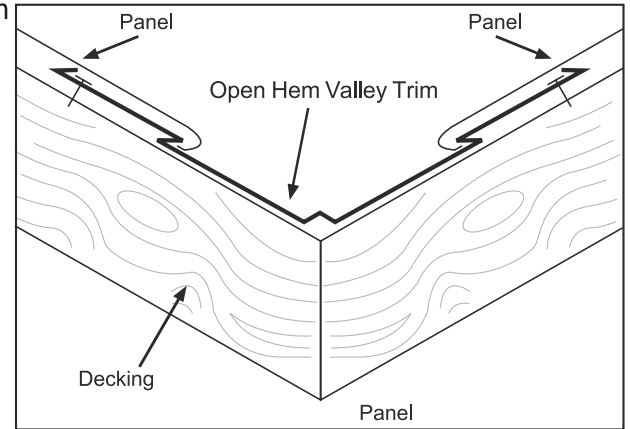

Many plants do not have an Open Hem Valley Flashing. At these plants, use a standard valley and two offset cleats to get the same hidden fastener result. See the trim guide for more information.

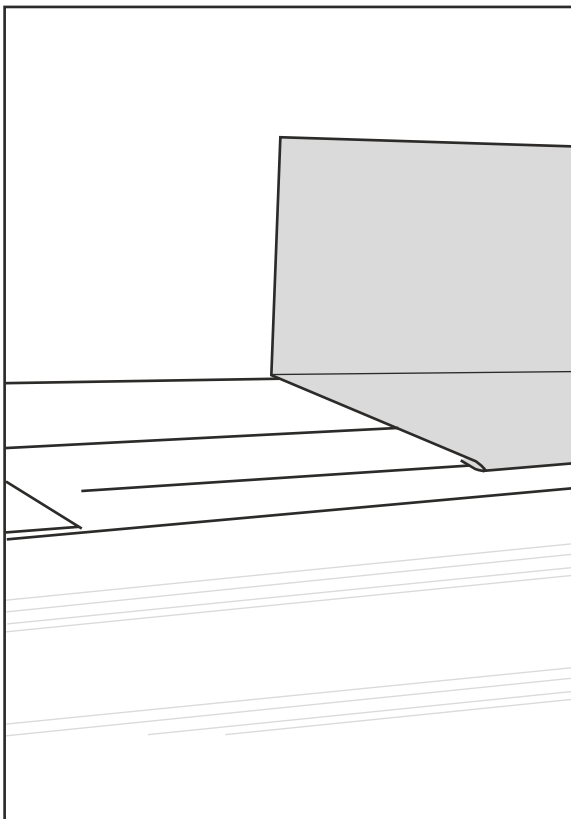
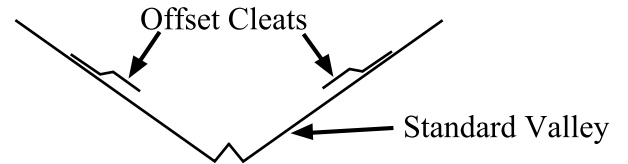

SIDEWALL & ENDWALL TRIM

1. Install ForeverSeam panels up to the sidewall. Install zee closure on top of the panel along the sidewall using butyl tape to ensure proper sealing. For endwall, zee closures will need to be cut in 15 - 1/2" lengths and screwed to the panel.
2. Install the sidewall trim over the zee and screw into the sidewall. Pop rivet the sidewall trim to the zee closure.
3. Repeat steps 1 and 2 for each panel along the sidewall.
4. Install ForeverSeam panels over the sidewall. Overlap trims a minimum of 3" with a butyl tape between laps.

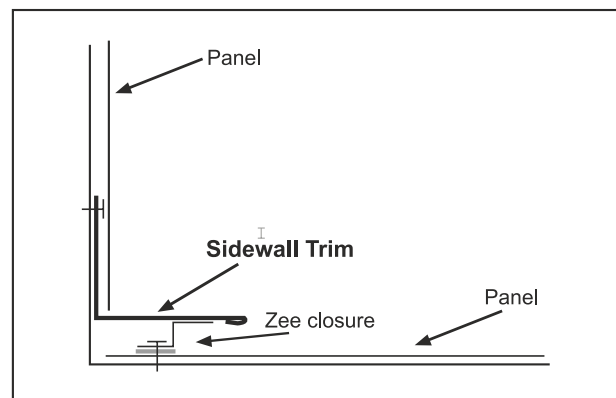

Installation of Trims (cont.)

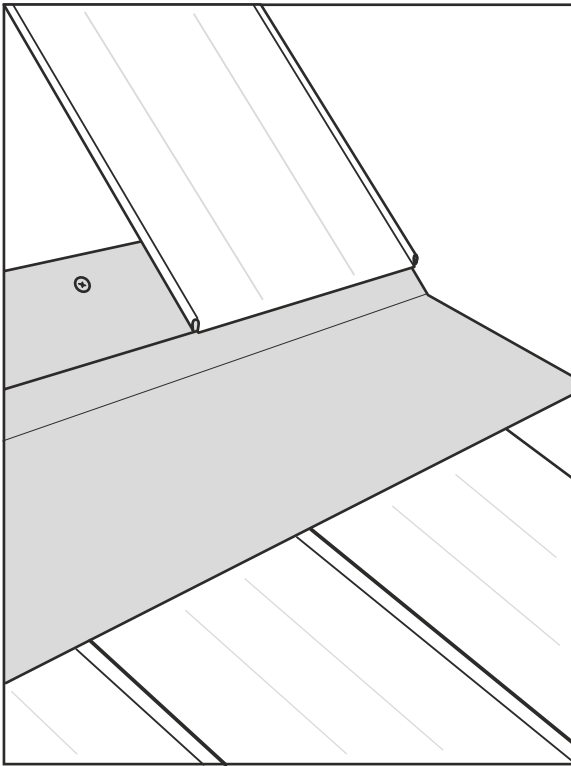

TRANSITION TRIM

1. Install the bottom ForeverSeam panels and attach zee closures. Zee closures will need to be cut in 15 - 1/2" lengths and screwed to the panel. Use butyl tape to ensure proper sealing.
2. Install the transition trim over zee, and screw transition to upper decking.
3. Notch and hem panel 1" and slide over open hem on transition. Screw panel to decking.
4. Repeat steps 1 through 3 for each panel along the transition. Overlap trims a minimum of 3" with butyl tape between laps.

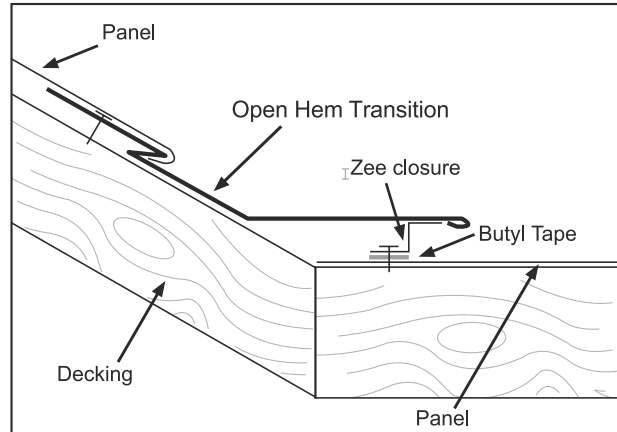

Many plants do not have an Open Hem Valley Flashing. At these plants, use a standard transition and an offset cleat to get the same hidden fastener result. See the trim guide for more information.

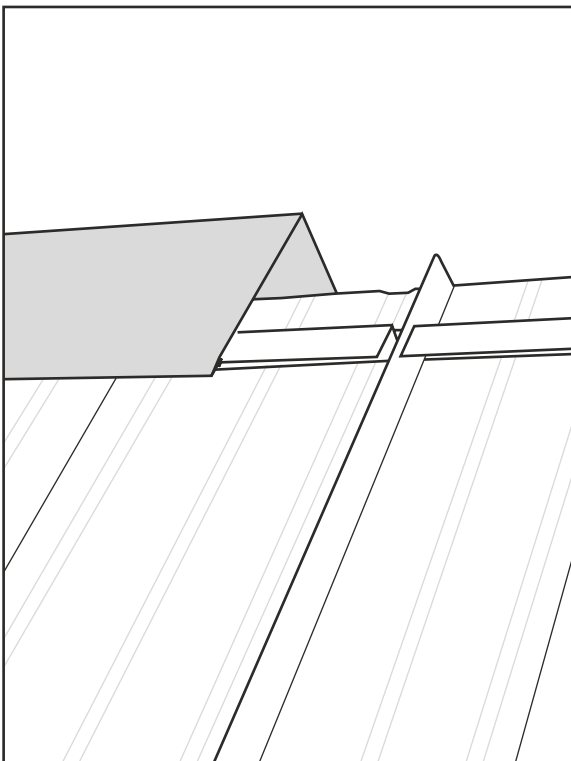
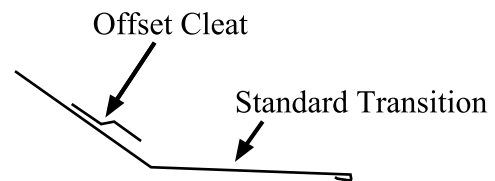

RIDGE GAP

1. Install panels on both sides of roof up to the ridge, and install zee closures. Zee closures will need to be cut in 15 - 1/2" lengths and screwed to the panel. Use butyl tape to ensure proper sealing.
2. Install ridge cap over zee closures and pop rivet to the zee every inch and at joints.
3. When overlapping ridge cap, cut 6" off bottom hem of the underlapping ridge cap and slide upper ridge cap over. Pop rivet with sealant on each lap. Overlap trims a minimum of 6" with butyl tape or sealant between laps.

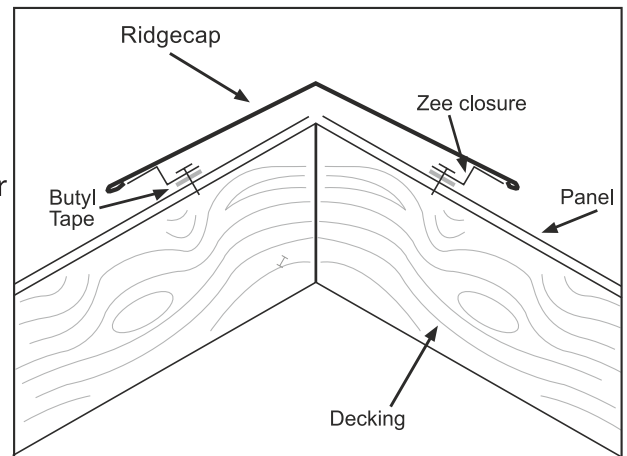

Accessories

Pipe Flashings

Anything that goes through a metal roof needs properly flashed. Penetrations such as plumbing vents or gas vents are sealed with special flashings made specifically for metal roofing. These flashings consist of a conical boot (EPDM or High Temperature Silicone) and a flexible aluminum flange.

Flashing is easier to apply if it falls between the major ribs, but is not necessary. First, caulking or butyl tape is applied to the bottom of the flange. Then the flashing is pushed down over the pipe until the flange contacts the roof. Next, drive gasketed screws every inch or so around the perimeter of the flange.

Available Pipe Flashings:

- #1 Split/Zipper Boot Small - 1/4" to 2 1/2"
- #2 Split/Zipper Roof Boot Large - 2" to 7 1/4"
- #3 Hi-Temp Pipe Boot - 1/4" to 5"
- #3 Pipe Boot - 1/4" to 5"
- #5 Hi-Temp Pipe Boot - 4 1/4" to 7 1/2"
- #5 Pipe Boot - 4 1/4" to 7 1/2"
- #6 Pipe Boot - 5" to 9"
- #8 Hi-Temp Pipe Boot - 7" to 13"
- #8 Pipe Boot - 7" to 13"
- #9 Hi-Temp Pipe Boot - 10" to 19"
- #9 Pine Boot - 10" to 19"

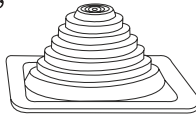

Touch-Up Paint

All painted panels and trims have a factory applied baked-on finish. Handling and installing panels may result in some small scratches or nicks to the paint finish. Surface scratches which are not too obvious from a distance of six feet are generally best left untouched, since normal soiling and weathering will mask them. Touch-up paint is available in matching colors for

other small blemishes. Touch-up paint does not have the superior chalk and fade resistance of the factory applied paint finish and will normally discolor at an accelerated rate; therefore, touch-up painting of large areas is not recommended. Periodic touch-up may be required to maintain color match. There is no warranty on touch-up paint in regards to color match because the paint processes are different. Touch-up paint should be used sparingly and only to cover up those areas where paint has been removed. Areas to be touched-up should be wiped with mineral spirits to remove dirt, wax or other contaminants before colored touch-up is applied.

Other Available Accessories:

Butyl Tape

Closures (w/adhesive)

Painted Metal-to-Wood Screws

(1", 1 1/2", 2", 2 1/2", 3")

Ridge Vent

Tripolymer sealant

Benefits of a Metal Roof

ADVANTAGES

In addition to its fire resistance, steel roofing is long-lasting, lightweight, easy to install, and easy to maintain. Asphalt shingles degrade when exposed to sun, wind and carpenters' feet. The painted finish on a metal roof will not break down from exposure to wind, rain, sleet, or snow. And because metal roofing is one solid panel from eaves to peak and is screwed to the roof sheathing, it's not likely to blow off in a gale as asphalt shingles often do.

Tile roofing is resistant to fire as well as weather, but its rough surface can collect leaves and debris, especially in roof valleys. Removing debris from a tile roof is complicated by the fact that walking on the tiles can damage them. Walking on a steel roof installed over solid decking will not damage the steel. Also, the smooth painted surface of steel roofing discourages debris from accumulating. And when properly installed, it's just plain tough to beat the crisp, clean, colorful lines of a steel roof.

WARRANTY

Our 26 gauge steel roofing carries a 40 year paint warranty or 25 year galvalume warranty.

ECOLOGICAL BENEFITS OF METAL ROOFS

With today's heightened interest in and demand for ecologically-sound building materials, metal roofing rises to the top as the product of choice for all types of construction. The Metal Construction Association ardently supports that metal roofing should be included on all lists of environmentally-friendly or "green" roofing materials.

The ecological benefits of metal roofing include:

- **Sustainability** – Metal roofing's durability can virtually eliminate the need for future raw materials to be used to produce roofing. Other roofing materials are heavily affected by weather extremes. Metal roofing, however, is unaffected by the hot-cold/wet-dry weather cycle that breaks down other materials. In addition, it is known for its ability to hold up against other weather

extremes including windstorms, hail, ice, and snow. No other roofing material has greater ability to withstand a wider range of weather conditions than metal. There are many hand-made metal roofs still in existence that date back to the 1800s. Commercially-produced metal roofing systems have been available since about 1910; numerous profiles and types have been produced since then and there are examples of these roofs across the country. While some metal roofs are quite long lasting and durable with exposed metallic surfaces, modern technology has also brought quality paint systems that beautify metal roofing and are warranted for thirty years. If necessary many years in the future, metal roofs can be repainted for additional life. As America's homes and other structures age, it is imperative that we choose long-term building products; the sustainability of metal roofing fits that role very well.

ECOLOGICAL BENEFITS (cont.)

- **Recycled Content** – As consumers, many of us are careful to collect our recyclable materials and turn them in for collection. In reality, though, we are offered very few consumer products where we can “close the loop” by purchasing products that are high in recycled content. Metal roofing, however, offers that option to consumers by allowing them to choose a significant building product on the basis of its recycled content. Most metal roofs have recycled content ranging from 25% to 30%. This is in stark contrast to conventional roofing shingles that have much shorter lives and use oil-based products as their primary raw material.
- **Recyclability** – While metal roofing is known for its extremely long life, it does have the added benefit of being 100% recyclable if it is ever removed in the future, perhaps as part of a building renovation. Whereas other old roofing materials are disposed of by the ton in landfills across the country each year, the steel used in metal roofing can be recycled in their entirety, potentially even to become another metal roof.
- **Low weight** – In comparison to heavy tile and slate roofing, the weight of metal roofing is minimal. This low weight serves several valuable purposes. First, it puts less weight load on a structure. This helps extend the life of buildings and it also provides invaluable protection against roof cave-in threat in the event of seismic activity. However, with retrofit applications, many metal roofs can be installed over the old roofing material. This has a very positive benefit by preventing the need to remove the old roof and fill up valuable landfill space. Each year, about 20 billion pounds of old composition roofing shingles are dumped into U.S. landfills. Metal roofing is the way to avoid this. Additionally, metal’s low weight and high strength presents an ideal way to cover and encapsulate existing asbestos roofing shingles rather than pose a health risk by removing them and putting them in a landfill. State EPA offices support this practice of asbestos shingle encapsulation.
- **Product Safety** – Metal roofing and the finishes used on it are very inert, safe materials that do not pose a health risk. Of course, one roofing material that has turned out to be very dangerous is the asbestos shingle roofing. This material was used extensively many years ago and now, having realized the health hazards it poses, we’re spending many dollars each year to get rid of. This worry does not exist with metal. The fact that metal roofing has zero “out-gassing” also makes it ideal for consumers with chemical sensitivities. Today’s commercially-produced metal roofing systems are carefully tested on an ongoing basis for performance, wind resistance, fire resistance, and hail resistance. They are listed with various building codes and entities including Underwriters Laboratories, International Congress of Building Officials, Dade County, Florida, Southern Building Code Congress International, and others.
- **Energy Efficiency** – Metal roofing is rapidly gaining acceptance as a very energy efficient material. Property owners have reported energy savings of as high as 20% and even more after installing metal roofing. The reflectivity and subsequent energy efficiency of metal roofing has been confirmed in studies done by Florida Solar Energy Center, Florida Power and Light, Oak Ridge National Laboratory, and other independent organizations. Many available metal roofs are being documented to meet Energy Star requirements. This can have a tremendous impact on energy usage by reducing air conditioning costs and the smog and pollution that are created by the production of that energy. Additionally, the low thermal mass of metal roofing means that it dissipates heat very quickly once the sun goes behind a cloud or sets for the day. Other roofing materials have greater thermal mass and will continue to radiate captured heat into the structures beneath them even when the sun is not shining.

PRACTICAL BENEFITS

Some interesting work has been done and/or is underway. Here are some highlights:

- Florida Power & Light built six identical 1700 S.F. residences in Ft. Meyers. They found painted metal roofs save 23% in energy costs over asphalt shingles.
- A study at a Florida university shows attic temperatures to be 30° F lower with prepainted metal roofs vs. asphalt shingles.
- Calculations indicate a large city converting to prepainted metal roofing could reduce energy costs by \$1,000,000. Due to less power demand, there would be significantly reduced air pollution and its associated health benefits.
- Maintenance – The only recommended maintenance is a routine washing with clean water.

MAINTENANCE

With a little care and attention during service, a prepainted Galvalum® sheet will provide an extended service life. While durable, factory-applied finishes for metal building panels will last many years longer than ordinary paints; they should be cleaned thoroughly on a routine basis whenever the finish is not washed by rain. Applications where the paint finish is automatically washed by rain, such as roofing, do not require this maintenance.

Cleaning restores the appearance of the building, making repainting unnecessary, and maintains a pleasing appearance, as well as removing the buildup of corrosive materials. Applications requiring maintenance cleaning include soffits, siding under eaves, garage doors and the undersides of eave gutters.

Cleaning

In many cases, washing the painted surface with clean water from a garden hose will remove most of the dirt and accumulated deposits. Ideally, washing should be done at least every six months and more frequently in coastal areas where marine salt spray is prevalent or where high levels of industrial fallout occur. In cases where spray washing is ineffective in cleaning stubborn dirt, mild detergents or household ammonia solutions can be used as described below. In all cases, test a small unobtrusive area for color-fastness before cleaning large areas.

- Use one cup of Tide (or other common detergent containing less than 0.5% phosphate) dissolved in five gallons of warm water.
NOTE: Detergents containing greater than 0.5% phosphate are not recommended for use in general cleaning of building panels.
- OR use one cup of household ammonia dissolved in five gallons of water at room temperature. Never mix ammonia with any kind of bleach.
- Never blend cleaners and bleach yourself. If bleach and detergent are required, use detergents containing bleach.

Using either solution, work from the top to the bottom of panels with a well-soaked soft cloth, sponge, brush with very soft bristles, or low-pressure spray washer to clean the surface. Washing from the top down avoids streaking. Application should be gentle to prevent shiny spots. Scouring powders or industrial solvents are not recommended, since they may damage the paint film. Solvent-containing cleaners such as Fantastik are very effective and can be used.

If mildew or other fungal growth is a problem and cannot be removed as described above, detergent containing bleach, such as Tidewith Bleach, is recommended. The surface should be thoroughly rinsed with water after cleaning to remove traces of detergent.

801 W. Springhill Dr. Terre Haute, IN 47082

www.metalsupplydepot.com | 855-23METAL